

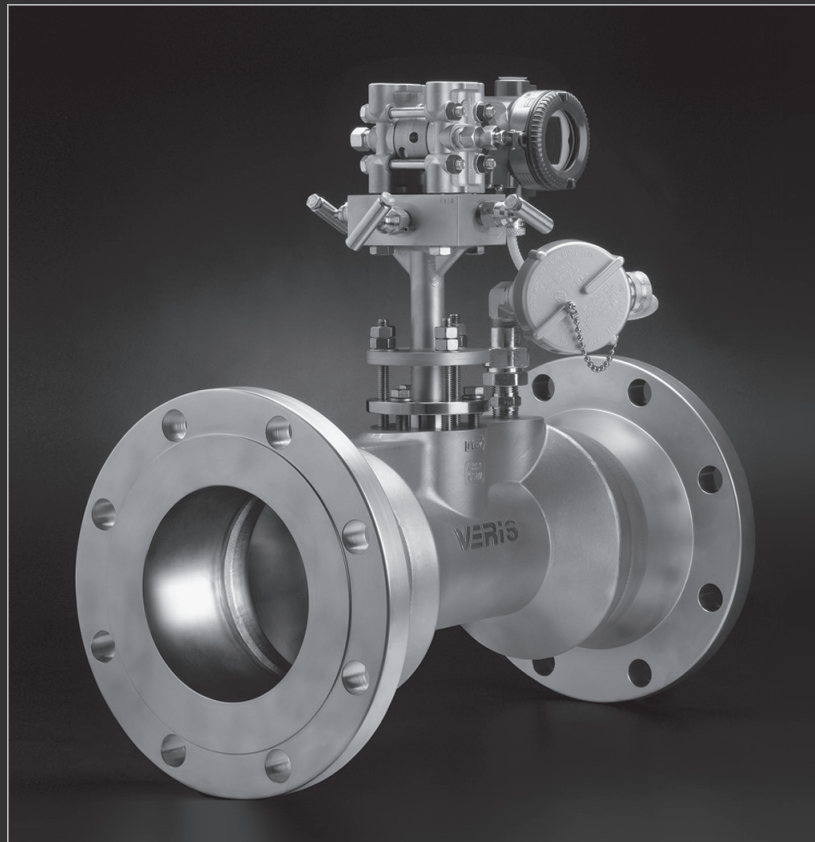

VERIS ACCELABAR®
SUPERIOR FLOW MEASUREMENT ACCURACY





VERIS Accelabar® ...A New Idea in Flow Measurement

The Unique VERIS Accelabar® Flow Meter

The VERIS Accelabar® is a new and unique DP primary flow element that combines two differential pressure technologies to measure flow at operating ranges never before attainable in a single DP flow meter. It is capable of generating high differential pressures for measuring gas, liquids and steam at turndowns previously unattainable—with no straight run requirements.

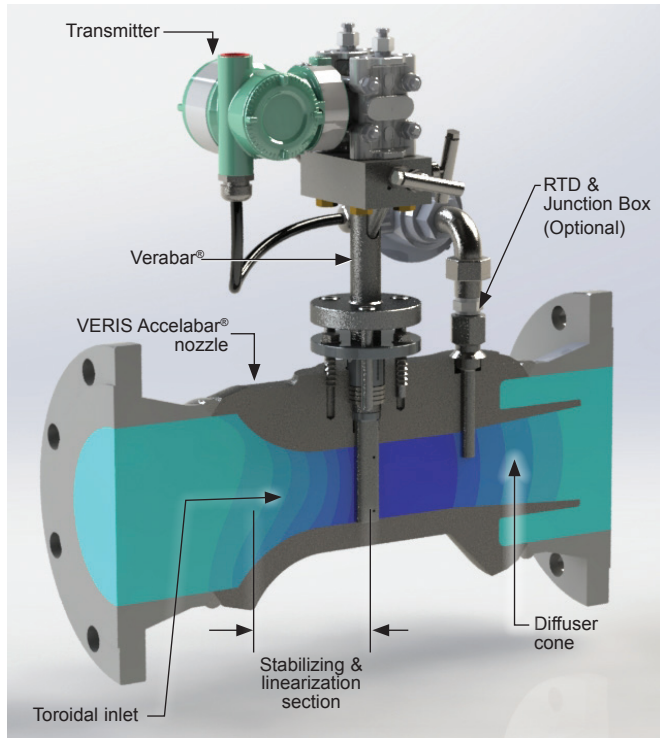

How the VERIS Accelabar® Works

The VERIS Accelabar® consists of a unique toroidal nozzle design and the VERIS Verabar® averaging pitot. The nozzle has a patented geometry that accelerates, linearizes and stabilizes the velocity profile sensed by the VERIS Verabar®. The VERIS Verabar® located after this “settling distance” and in the throat of the VERIS Accelabar® accurately measures and significantly increases the differential pressure to increase the operating range (turndown). The VERIS Accelabar® has a linear, Reynolds number Independent flow coefficient with an accuracy of up to $\pm 0.50\%$.

Other manufacturers claim high accuracy, but over a limited turndown.

No Straight Run Required

The VERIS Accelabar® can be used in extremely limited straight run piping configurations. The straight run is integral to the meter. The stabilization and linearization of non-uniform velocity profiles within the throat of the nozzle eliminates the need for any upstream run.

US Patent No. 6,868,741 B2 and various foreign patents pending.

Engineering Specifications

- Low velocity pipe flow rates
- High flow coefficient accuracy: to $\pm 0.50\%$
- Repeatability: $\pm 0.050\%$
- Linear, Independently Verified flow coefficients
- No calibration of primary flow element required
- Wide range of flow; Up to 65:1 turndown (application dependent)
- No straight run requirements
- Mass or volumetric flow

Actual Application

| | |
|---|-----------------------------|
| Application: | 3" Sch 40 Natural Gas |
| Operating Pressure/ Temperature: | 50 PSIG/70°F |
| Max/Min Flow Rate: | 60,000 SCFH/1,000 SCFH |
| Flow Turndown: | 60:1 (Stacked Transmitters) |
| Straight Run: | 0" |

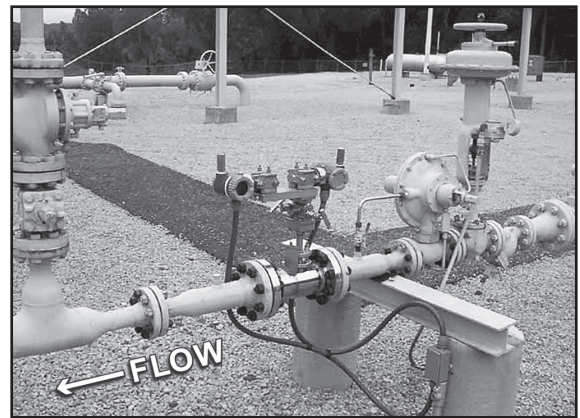

VERIS Verabar® Provides the Accuracy

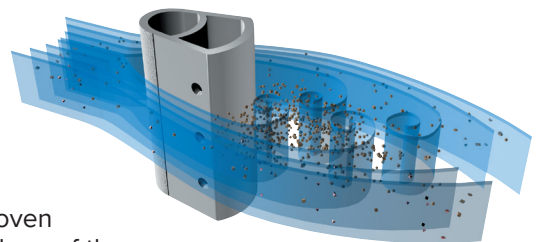

The proven technology of the VERIS Verabar® makes the VERIS Accelabar® work. It accurately measures the flow rate within the nozzle. Its unique bullet shape, constant flow coefficient, solid one-piece construction, non-clog design and signal stability make it the only design capable of producing the overall performance.

Designs, materials, weights and performance ratings are approximate and subject to change without notice. Visit armstronginternational.com/veris for up-to-date information.

VERIS Accelabar® ...Performance Characteristics

Comparative Analysis vs. Other Flow Meters

The VERIS Accelabar® fills the need not presently being filled by other flow meters for applications that:

- Do not have sufficient velocity to produce a readable signal or sufficient turndown
- Require the highest accuracy over an extended range
- Have little or no straight run piping before the meter

The VERIS Accelabar® performance characteristics far exceed those of other DP primary elements, vortex meters and many other types of flow meters.

These charts show the actual performance characteristics of the VERIS Accelabar® versus other flow meters based on the following flow conditions:

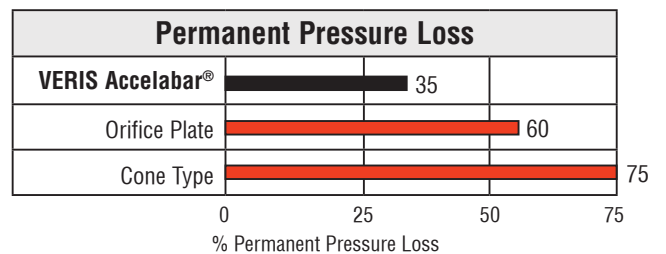
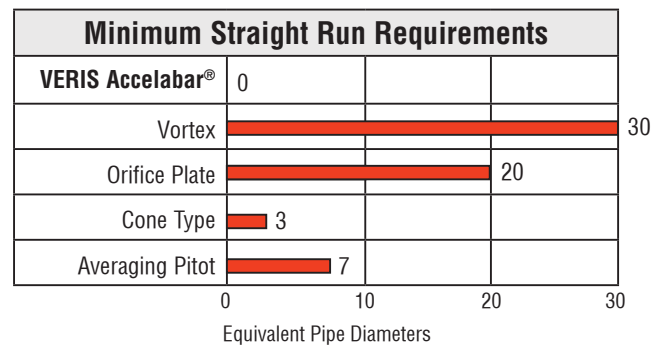
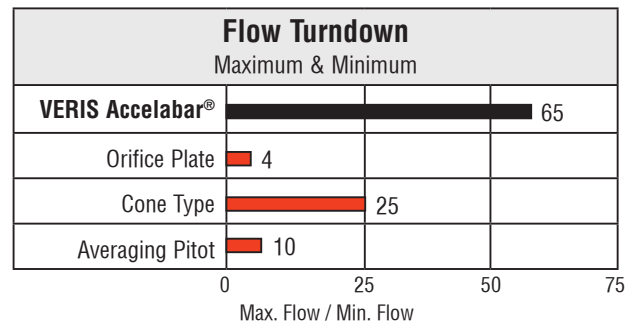



VERIS Accelabar® ...Test Data

Verified Accuracy and Flow Coefficients

Empirical TEST DATA from independent laboratories verified an analytical model and flow coefficients as constant and independent of Reynolds Number, and within +/- 0.5% of the predicted value over an extended turndown in flow.

This eliminates the need for calibration.

The Proof Is In The Data

Many flow meters claim high accuracy and rangeability or turndown. However, few manufacturers define their limitations and even fewer can support it with actual test data. The tests below show the performance capabilities of the VERIS Accelabar®.

Tested at CEESI (an independent Flow Lab)

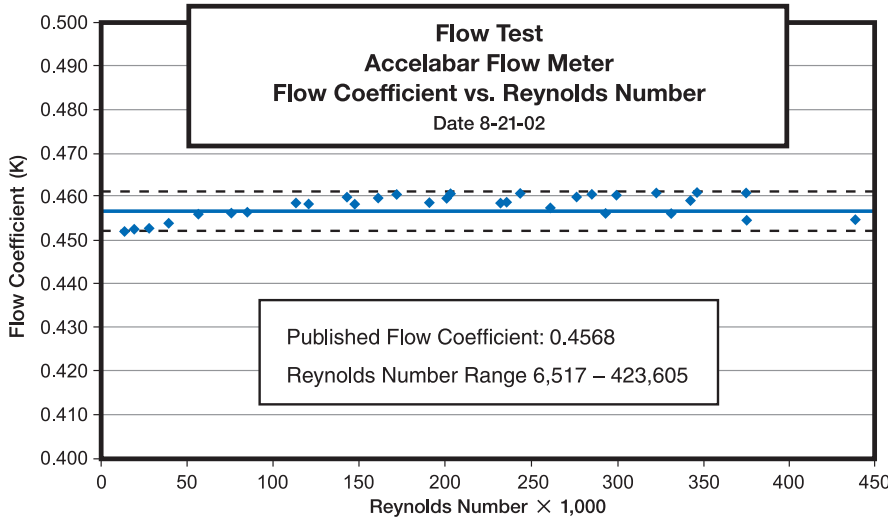

*Independent, NIST traceable tests were performed as follows:

- Air tests in 3", 4", 6" and 12" pipes
 - NIST traceable water tests
 - Large turndown natural gas testing
 - Short straight-run testing
- Consult factory for a copy of certified tests.

No Straight Run Test Comparison

Test Specifications

The VERIS Accelabar® was tested immediately downstream of a valve, tee elbow, and expander assembly with no straight run upstream.

Results

The short run test plotted with the standard straight run test verifies there is no shift in the flow coefficient.

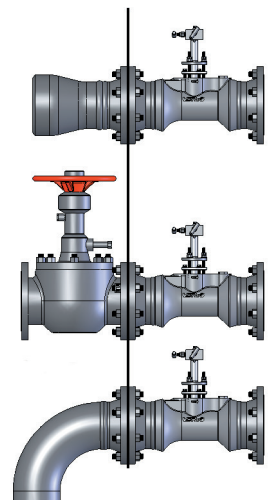
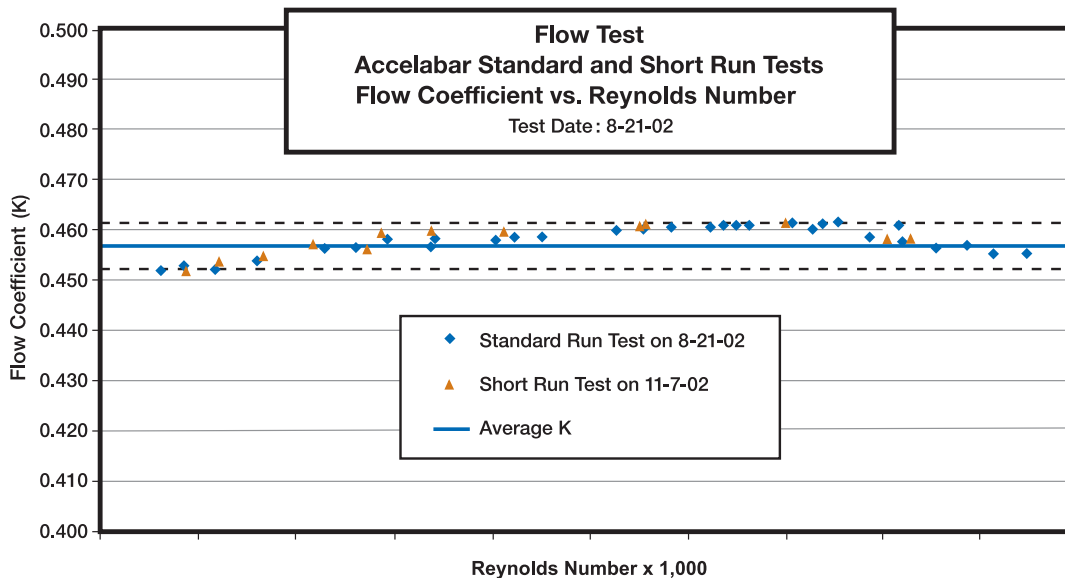

VERIS Accelabar[®] 1 – 12 Inch

Ready to Install

The VERIS Accelabar[®] combined with a DP transmitter is a complete flow meter ready to install. It may be used with single or dual transmitters depending on the turndown and accuracy requirements.

An optional RTD is available in a welded thermowell assembly for dynamic, real-time density compensation (required for use with multi-variable transmitter's in certain applications).

Specifications

| Sensor | Body | Flange | Accuracy | Repeatability |
|--------|------|--------|------------|---------------|
| 316SS | C8FM | 304SS | to ± 0.50% | ± 0.050% |

VERIS Accelabar[®] Model Selection

- Furnish your flowing conditions. A flow calculation is required to determine the DP and verification of the operating limits.
 - Each meter size has a standard beta ratio sized for the optimal operating range.
 - The maximum operating limits are determined by the VERIS Veracalc[®] flow sizing software.
- If your flowing conditions exceed or limit selection of the body size that matches the pipe size, a larger or smaller Accelabar[®] body can be selected for optimal operating results...

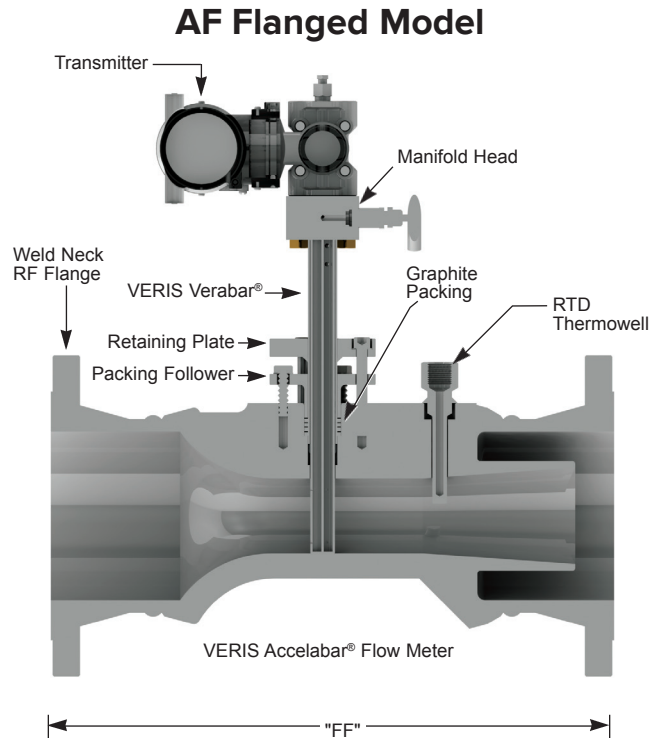



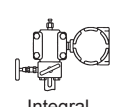
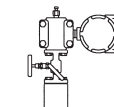
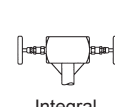
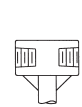



Chart A

| Meter Size | Verabar [®] Sensor | Face-to-Face "FF" | | | | | | | |
|----------------|-----------------------------|---------------------|---------------------|----------------------|---------------------|---------------------|---------------------|---------------------|---------------------|
| | | Class 150# | Class 300# | Class 600# | PN10 | PN16 | PN40 | PN63 | PN100 |
| 1" (DN25) | -03 | 7.50" (190.5mm) | 8.25" (209.6mm) | 8.75" (222.3mm) | N/A | N/A | 10.15" (257.8mm) | N/A | 11.57" (293.5mm) |
| 2" (DN50) | -05 | 8.75" (222.3mm) | 9.38" (238.3mm) | 10.13" (257.3mm) | 11.54" (293.2mm) | 11.54" (293.2mm) | 11.78" (299.2mm) | 12.88" (327.2mm) | 13.35" (339.2mm) |
| 3" (DN80) | -05 | 13.78" (350.0mm) | 14.53" (369.1mm) | 15.28" (388.1mm) | 12.31" (312.8mm) | 12.31" (312.8mm) | 12.94" (328.8mm) | 14.04" (356.8mm) | 14.52" (368.8mm) |
| 4" (DN100) | -05 | 15.15" (384.8mm) | 15.90" (403.9mm) | 17.65" (448.3mm) | 13.34" (338.9mm) | 13.34" (338.9mm) | 14.36" (364.9mm) | 15.39" (390.9mm) | 16.34" (414.9mm) |
| 6" (DN150) | -10 | 19.15" (486.4mm) | 19.90" (505.5mm) | 21.90" (556.3mm) | 16.58" (421.1mm) | 16.58" (421.1mm) | 18.15" (461.1mm) | 19.73" (501.1mm) | 21.30" (541.1mm) |
| 8" (DN200) | -10 | 21.40" (543.6mm) | 22.15" (562.6mm) | 24.40" (619.8mm) | 18.38" (466.9mm) | 18.38" (466.9mm) | 20.42" (518.9mm) | 22.16" (562.9mm) | 23.74" (602.9mm) |
| 10" (DN250) | -10 | 23.15" (588.0mm) | 24.40" (619.8mm) | 27.65" (702.31mm) | 20.60" (523.3mm) | 20.76" (527.3mm) | 23.51" (597.3mm) | 25.09" (637.3mm) | 27.61" (701.3mm) |
| 12" (DN300) | -10 | 26.22" (666.0mm) | 27.47" (697.7mm) | 29.97" (761.9mm) | 22.62" (574.6mm) | 23.41" (594.6mm) | 26.32" (668.6mm) | 28.29" (718.6mm) | 30.65" (778.6mm) |

*Nominal Face-to-Face dimensions nominal. Custom lengths available.

Designs, materials, weights and performance ratings are approximate and subject to change without notice. Visit armstronginternational.com/veris for up-to-date information.

VERIS Accelabar® ...Ordering Information

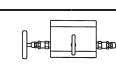
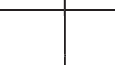
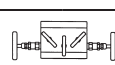
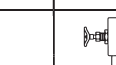
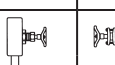
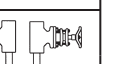
| | | | | | | | | | | | |
|---|---|---|---------------------|---|---|---|-----------------------|---|--|---|--|
| Model | VERIS Accelabar® 316SS | | | | | | | | | | |
| AFS | Flanged Connections | | | | | | | | | | |
| ABS | Bevel for Welded in Meter | | | | | | | | | | |
| ATS | MNPT Threaded Ends (2" meter only) | | | | | | | | | | |
| User Mating Pipe Size and Schedule or Exact ID and Wall Thickness | | | | | | | | | | | |
| Code | User Mating Flange (Model AFS Only) | | | | | | | | | | |
| 150 | 150# ANSI Class 275 psig @ 100°F, 80 psig @ 800°F (19 Bars @ 38°C, 5.5 Bars @ 426°C) | | | | | | | | | | |
| 300 | 300# ANSI Class 720 psig @ 100°F, 330 psig @ 800°F (49.6 Bars @ 38°C, 22.8 Bars @ 426°C) | | | | | | | | | | |
| 600 | 600# ANSI Class 1440 psig @ 100°F, 660 psig @ 800°F (99.3 Bars @ 38°C, 45.5 Bars @ 426°C) | | | | | | | | | | |
| If other than ANSI, specify Standard (DIN, JIS) Size and Rating | | | | | | | | | | | |
| Code | Flange Material | | | | | | | | | | |
| S | 304 Stainless Steel (Standard) | | | | | | | | | | |
| C | 316 Stainless Steel (Optional) Carbon Steel (Optional) | | | | | | | | | | |
| VERIS Accelabar® Meter Size | | | | | | | | | | | |
| Important: If the selected meter size is larger or smaller than the user's mating pipe and flanges, expanders or reducers are required. Consult the factory for price and delivery. | | | | | | | | | | | |
| | 1" (25mm) | 2" (50mm) | 3" (75mm) | 4" (100mm) | 6" (150mm) | 8" (200mm) | 10" (250mm) | 12" (300mm) | | | |
| Code | VERIS Verabar® Size | | | | | | | | | | |
| 05 | 7/16" (11mm) | | | | | | | | | | |
| 10 | 7/8" (22mm) | | | | | | | | | | |
| Code | Pipe Orientation | | | | | | | | | | |
| H | Horizontal | | | | | | | | | | |
| V | Vertical | | | | | | | | | | |
| Instrument Head Connections (Select Remote or Direct Mount Transmitter—Sold Separately) | | | | | | | | | | | |
|  Direct Mount Transmitter (Flanged 450°F/232°C Max.) | | | | |  Remote Mount Transmitter (1/2" NPT) | | | | | | |
| Manifold | | Transmount | | Valve | | Regular | | Parallel | | | |
|  | |  | |  | |  | |  | | | |
| Integral | | Integral | | Integral | | | | | | | |
| M | | F | | T | | R | | P | | | |
| Manifolds (Optional) | | | | | Instrument Valves (Optional) | | | | | | |
|  Direct Mount | | | | |  Remote Mount | | | | | | |
| 3-Valve | | | 5-Valve | | | Needle | | Gate | | | |
|  | |  | |  | |  | |  | |  | |
| Soft Seat | | Hard Seat | | Soft Seat | | Hard Seat | | 1/2" NPT | | 1/2" NPT | |
| F3SC (CS) | | F3HC (CS) | | F5SC (CS) | | F5HC (CS) | | C2NC (CS) | | C2GC (CS) | |
| F3SS (SS) | | F3HS (SS) | | F5SS (SS) | | F5HS (SS) | | C2NS (SS) | | C2GS (SS) | |
| Code | RTD in Thermowell | | | | | | | | | | |
| H1 | Standard Temperature (500°F, 260°C Max) | | | | | | | | | | |
| HT | High Temperature (500°F to 900°F, 260°C to 482°C) | | | | | | | | | | |
| Code | Connection Cable to Transmitter (Direct Mount Only) | | | | | | | | | | |
| XP | Explosion Proof (hazardous locations) | | | | | | | | | | |
| N4 | NEMA 4 | | | | | | | | | | |
| AFS | 6" Sch40 | 150 | 6 | 05 | H | M | | | | | |

VERIS Accelabar® ...The Best Choice in Flow Meters

Transmitter Selection

VERIS Accelabar® primary flow coefficient accuracy is percent of rate. The VERIS Accelabar® maintains a constant flow coefficient over a wide range of flow rates and differential pressures.

DP transmitter accuracy is percent of scale. While most VERIS Accelabar® installations are equipped with one DP transmitter, some applications requiring superior accuracy over an extreme DP turndown, may require a dual DP transmitter installation.



Single Transmitter

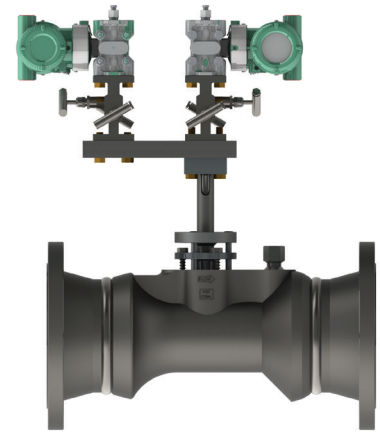

Dual Transmitter

Installation Orientation

Direct Mount

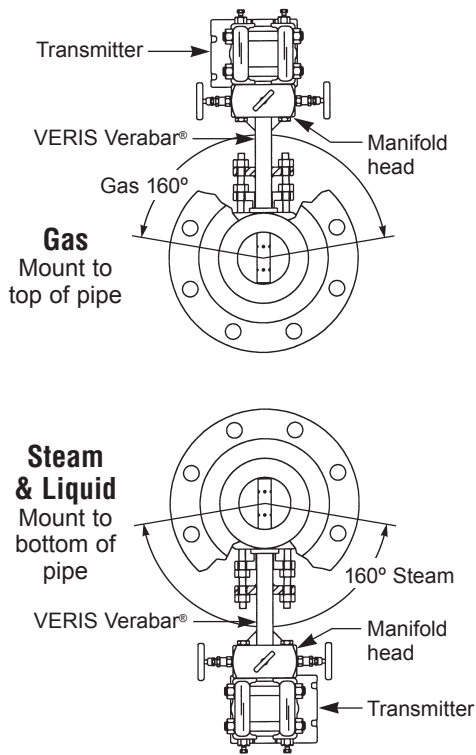

Remote Mount

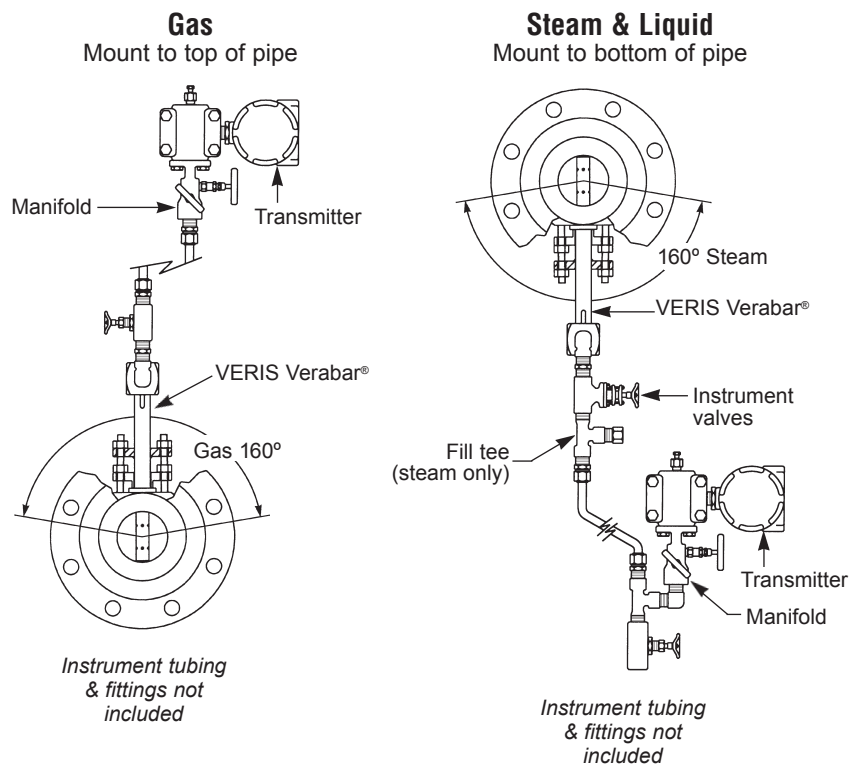

VERIS Accelabar® ...True Performance in Flow Measurement

Designs, materials, weights and performance ratings are approximate and subject to change without notice. Visit armstronginternational.com/veris for up-to-date information.



INTELLIGENT SOLUTIONS IN STEAM, AIR, AND HOT WATER

Armstrong International

North America • Latin America • India • Europe / Middle East / Africa • China • Pacific Rim

armstronginternational.com